

Hydraulic cylinders type CN - round heads with counterflanges

to ISO 6020-1 - nominal pressure 16 MPa (160 bar) - max 25 MPa (250 bar)

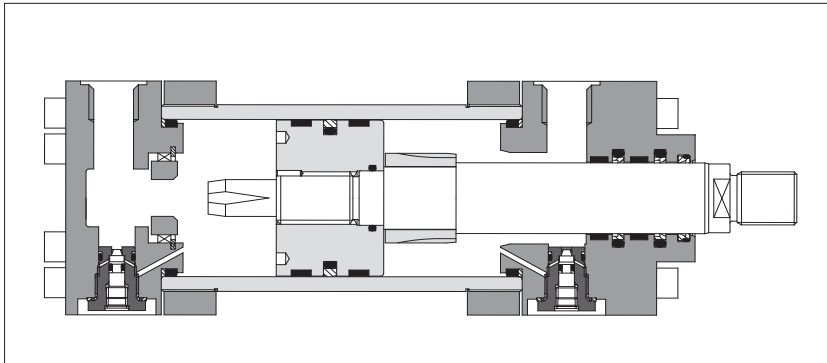

CN cylinders have engineered double acting construction, designed to suit the requirements of industrial applications: top reliability, high performances and long working life.

- Bore sizes from **40 to 200 mm**
- **2** rod diameters per bore
- Strokes up to **5000 mm**
- Rods with **rolled threads**
- **9** standard mounting styles
- **3** seals options
- Rod guide rings for low wear
- Adjustable or fixed cushioning
- Optional built-in position transducer, **see tab. B310**
- Attachments for rods and mounting styles, **see tab. B500**

For cylinder's choice and sizing criteria **see tab. B015**

SWC Cylinders Designer

Software for assisted selection of Atos cylinders & servocylinders codes, including cylinder's sizing, full technical information, 2D & 3D drawings in several CAD formats.

Available for download at www.atos.com

1 MODEL CODE

CN	F	-	50	/	28	*	0500	-	S	3	0	8	-	A	-	B1E3X1Z3	**
<p>Cylinder series CN to ISO 6020 - 1</p> <p>Rod position transducer - = omit if not requested F = magnetosonic M = magnetosonic programmable N = magnetostrictive P = potentiometric V = inductive Transducer available on request, contact our technical office</p> <p>Bore size, see section 4 from 40 to 200 mm</p> <p>Rod diameter, see sections 7 and 9 from 22 to 140 mm</p> <p>Stroke, see section 5 up to 5000 mm</p> <p>Mounting style, see sections 2 and 4</p> <p>REF. ISO MF3 MF4 MP3 MS2 MT4 (2) MF1 MF2 MP5 -</p>																	
<p>Oil ports positions B1 = front head X1 = rear head</p> <p>Cushioning adjustments positions, to be entered only if adjustable cushioning are selected E3 = front head* Z3 = rear head* * = enter E2 and Z2 for mounting style E</p> <p>Options (1): Oversized oil ports, see section 4 D = front oversized oil port Y = rear oversized oil port Rod treatment, see section 9 K = nickel and chrome plating T = induction surface hardening and chrome plating Air bleeds, see section 13 A = front air bleed W = rear air bleed Flange oil ports, see section 3 M = front and rear SAE 6000 flange oil ports</p> <p>Sealing system, see section 12 2 = (FKM + PTFE) very low friction and high temperatures 4 = (NBR + PTFE) very low friction and high speeds 8 = (NBR + PTFE and POLYURETHANE) low friction</p> <p>Spacer, see section 6 0 = none 2 = 50 mm 4 = 100 mm 6 = 150 mm 8 = 200 mm</p> <p>Cushioning, see section 10 0 = none Slow adjustable 1 = rear only 2 = front only 3 = front and rear Slow fixed 7 = rear only 8 = front only 9 = front and rear</p>																	
<p>Series number</p>																	

(1) To be entered in alphabetical order

(2) XV dimension must be indicated in the model code, see section 4

2 MOUNTING STYLE - for dimensions see section **4**

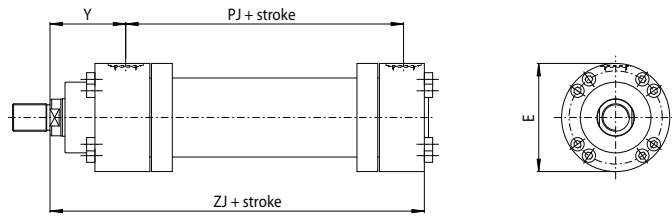
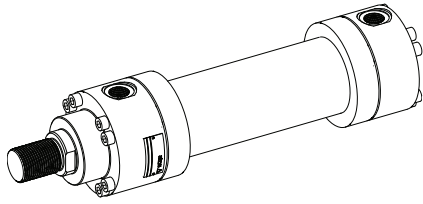

X = basic mounting

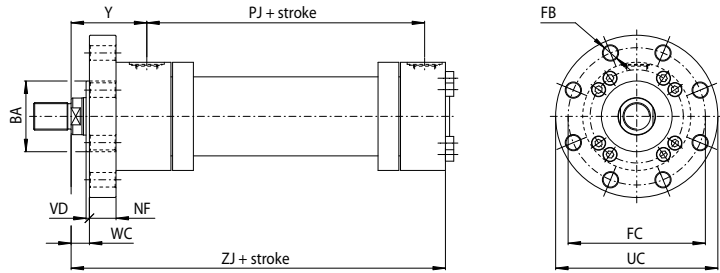
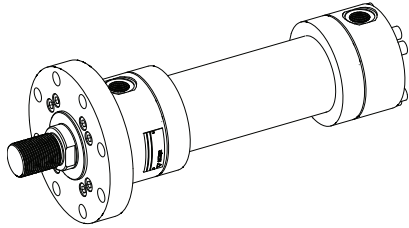

A (ISO MF3) = front round flange mounting

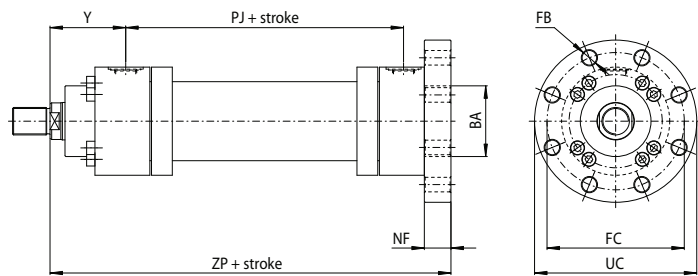
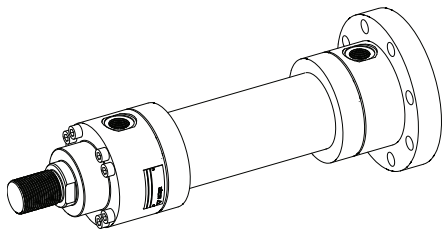

B (ISO MF4) = rear round flange mounting

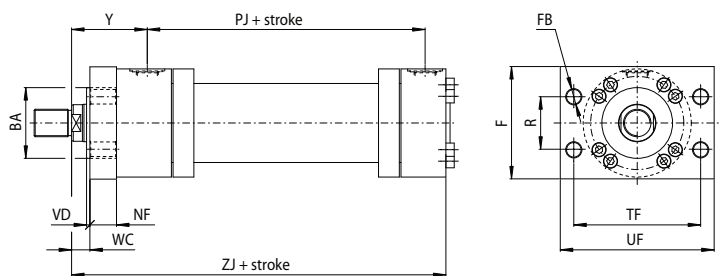
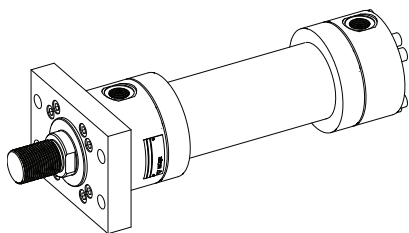

N (ISO MF1) = front square flange mounting (not for bores 160 - 200)

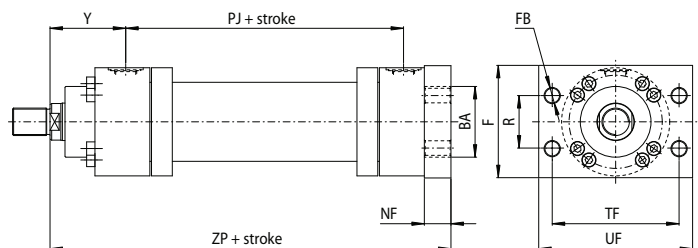
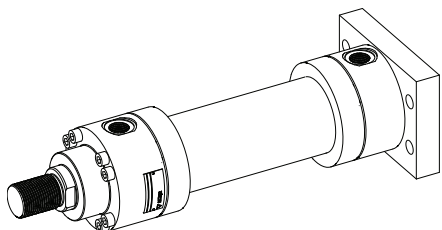

P (ISO MF2) = rear square flange mounting (not for bores 160 - 200)

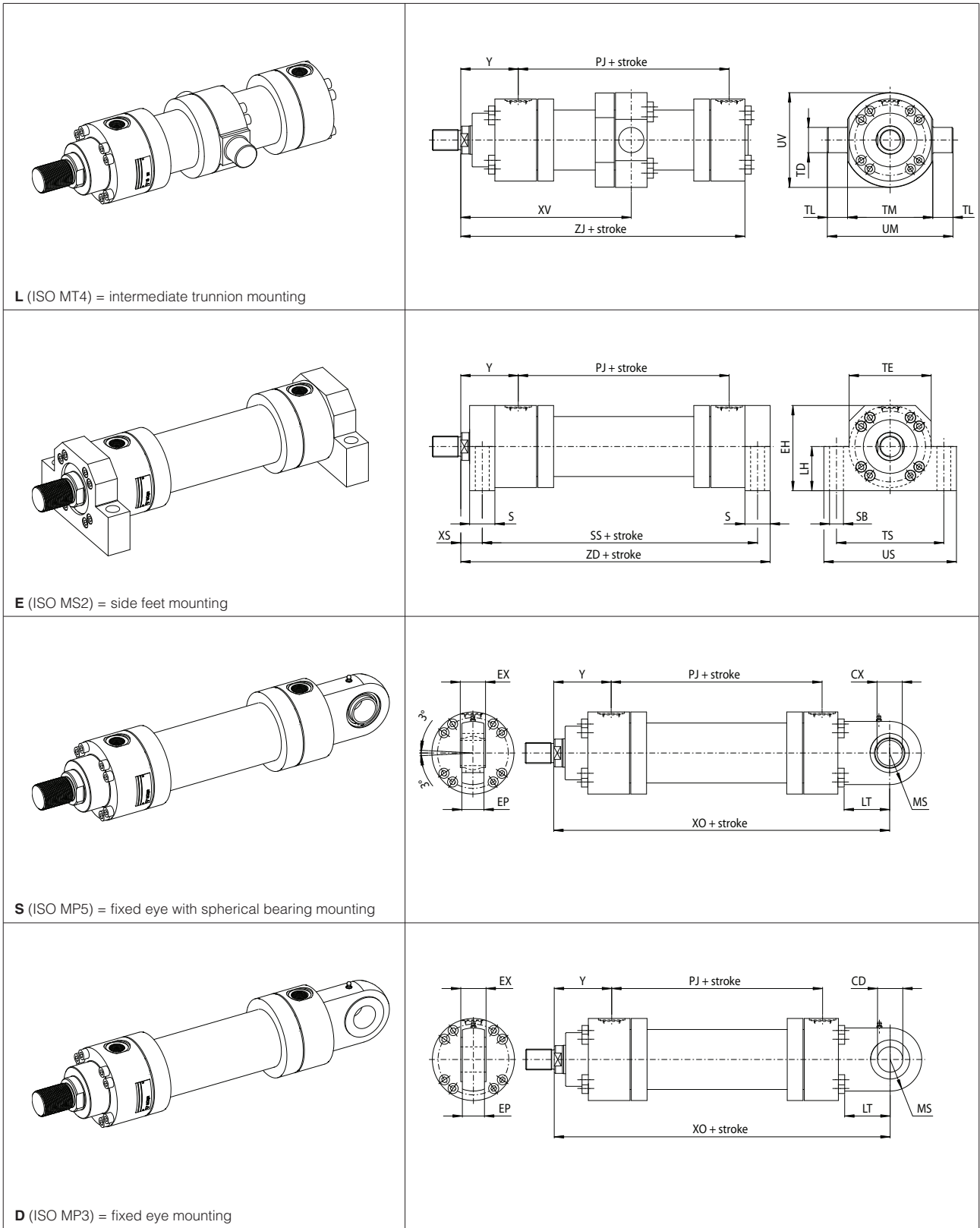

3 SAE 3000 FLANGE OIL PORTS - DIMENSIONS TO ISO 6162-1 [mm]

Ø Bore	DN	EC	EA ±0,25	EB ±0,25	ED 6g	FF 0 / -1,5
63	13	50	17.5	38.1	M8x1.25	13
80		58				
100	19	71	22.3	47.6	M10x1.5	19
125		89				
160	25	113	26.2	52.4	M10x1.5	25
200		137				

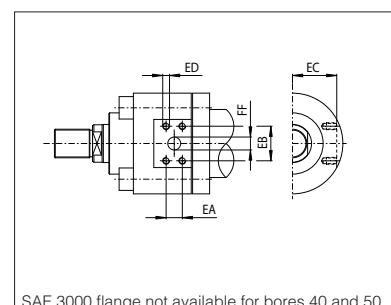

4 INSTALLATION DIMENSIONS [mm] - see figures in section 2

Ø Bore	40	50	63	80	100	125	160	200	
Ø Rod	Standard	22	28	36	45	56	70	90	110
	Differential	28	36	45	56	70	90	110	140
B / BA f8/H8	50	60	70	85	106	132	160	200	
CD / CX H9/H7	20	25	32	40	50	63	80	100	
D (1) min	29	29	36	36	42	42	52	52	
D1 (1) min	36	36	42	42	52	52	58	58	
E (2) max	78	95	116	130	158	192	238	285	
EE (1)	G 1/2	G 1/2	G 3/4	G 3/4	G 1	G 1	G 1 1/4	G 1 1/4	
EE1 (1)	G 3/4	G 3/4	G 1	G 1	G 1 1/4	G 1 1/4	G 1 1/2	G 1 1/2	
EH max	82	100	120	135	161	196	238	288	
EP	18	22	27	35	40	52	66	84	
EX h12	20	25	32	40	50	63	80	100	
F max	80	100	120	135	160	195	NA	NA	
FB H13	9	11	13.5	17.5	22	22	22	26	
FC js13	106	126	145	165	200	235	280	340	
LH h10	43	52	62	70	82	100	119	145	
LT min	25	32	40	50	63	71	90	112	
MS max	25	32	40	50	63	71	90	112	
MT [Nm] (3)	40	78	137	78	137	226	471	471	
NF js13	16	20	25	32	32	32	36	40	
PJ (5)	97	111	117	134	162	174	191	224	
R js13	40.6	48.2	55.5	63.1	76.5	90.2	NA	NA	
S js13	25	32	32	40	50	56	60	72	
SB H13	11	14	18	22	26	33	33	39	
SS (5)	183	199	211	236	293	321	364	447	
TD f8	20	25	32	40	50	63	80	100	
TE js13	78	95	116	130	158	192	238	285	
TF js13	98	116.4	134	152.5	184.8	217.1	NA	NA	
TL js13	16	20	25	32	40	50	63	80	
TM h12	90	105	120	135	160	195	240	295	
TS js13	100	120	150	170	205	245	295	350	
UC max	125	148	170	195	238	272	316	385	
UF max	115	140	160	185	225	255	NA	NA	
UM	122	145	170	199	240	295	366	455	
US max	120	145	180	210	250	300	350	415	
UV	90	108	124	150	180	219	280	333	
VD	3	4	4	4	5	5	5	5	
WC (5)	16	18	20	22	25	28	30	35	
XO (5)	231	257	289	332	395	428	505	615	
XS (5)	19.5	22	29	34	32	32	36	39	
XV (4)	minimum stroke for style L	55	55	85	90	110	135	170	190
	min	155	160	190	215	255	290	340	420
	max	100+stroke	105+stroke	105+stroke	125+stroke	145+stroke	155+stroke	170+stroke	230+stroke
Y (5)	71	72	82	91	108	121	143	190	
ZD	215	237	256	290	350	381	430	522	
ZP (5)	206	225	249	282	332	357	406	490	
ZJ (5)	190	205	224	250	300	325	370	450	

7 ROD END DIMENSIONS [mm]

Ø Bore	40	50	63	80	100	125	160	200
VE max	19	24	29	36	37	37	41	45
WF	32	38	45	54	57	60	66	75
Ø Rod Standard	22	28	36	45	56	70	90	110
A max	22	28	36	45	56	63	85	95
CH	19	22	30	39	48	62	80	100
KK 6g	M16x1,5	M20x1,5	M27x2	M33x2	M42x2	M48x2	M64x3	M80x3
Ø Rod Differential	28	36	45	56	70	90	110	140
A max	28	36	45	56	63	85	95	112
CH	22	30	39	48	62	80	100	128
KK 6g	M20x1,5	M27x2	M33x2	M42x2	M48x2	M64x3	M80x3	M100x3

NOTES TO TABLE 4

(1) **D, EE** - Oil ports are threaded according to GAS standard with counterbore dimension **D** according to ISO 1179-1 (see figure below). When oversized oil ports are selected (**D** = front oversized oil ports, **Y** = rear oversized oil ports) dimensions **D** and **EE** are respectively modified into **D1** and **EE1**

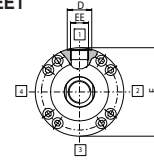

(2) **E** - If not otherwise specified in the figures in section 2, this value is the front and rear round heads dimension for all the mounting styles (see figure above)

(3) **MT** - Screws tightening torque. Mounting screws must be to a minimum strength of ISO 898/2 grade 12.9

(4) **XV** - For cylinders with mounting style **L** the stroke must always exceed the minimum values reported in the table. The requested **XV min** and **XV max** and it must be always indicated, with dimension in millimeters, together with the cylinder code. See the following example:

CN - 50 / 28 * 0500 - L308 - A - B1E3X1Z3
XV = 200

(5) The tolerance is according to the table below

Mounting dimensions	ZJ, ZP, XO, SS, PJ	WF, WC, XV, XS, Y
stroke < 1250	±1,5	±2
1250 > stroke < 3150	±3	±4
stroke > 3150	±5	±8

5 STROKE SELECTION

Stroke has to be selected a few mm longer than the working stroke, to prevent to use the cylinder heads as mechanical stroke-end.

Maximum stroke:
• 5000 mm

Stroke tolerances:

- 0 +2 mm for strokes up to 1250 mm
- 0 +5 mm for strokes from 1250 to 3150 mm
- 0 +8 mm for strokes over 3150 mm

6 SPACER

For strokes longer than 1000 mm, proper spacers have to be introduced in the cylinder's construction to increase the rod and piston guide and to protect them from overloads and premature wear. Spacers can be omitted for cylinders working in traction mode. The introduction of spacers increases the overall cylinder's dimensions: spacers' length has to be added to all stroke dependent dimensions in section 4.

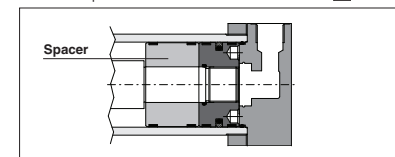

RECOMMENDED SPACERS [mm]

Stroke	1001 ÷ 1500	1501 ÷ 2000	2001 ÷ 2500	2501 ÷ 5000
Spacer code	2	4	6	8
Length	50	100	150	200

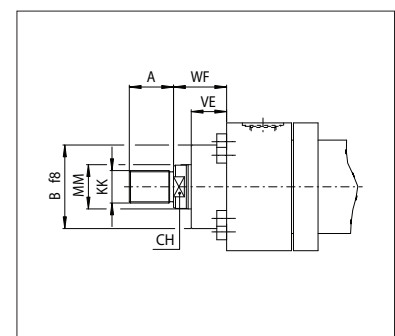

8 CYLINDER'S HOUSING FEATURES

The cylinder's housings are made in "cold drawn and stressed steel"; the internal surfaces are lapped: diameter tolerance H8, roughness Ra ≤ 0,25 µm.

9 RODS FEATURES and options

The rods materials have high strength, which provide safety coefficients higher than 4 in static stress conditions, at maximum working pressure. The rod surface is chrome plated: diameter tolerances f7, roughness Ra ≤ 0,25 µm. Corrosion resistance of 200 h in neutral spray to ISO 9227 NSS.

ø Rod	Material	Rs min [N/mm ²]	Chrome	
			min thickness [mm]	hardness [HV]
22÷90	hardened and tempered alloy-steel	700	0,020	850-1150
110÷140	alloy steel	450		

Rod diameters from 22 to 70 mm have rolled threads; in rolling process the component material is stressed beyond its yield point, being deformed plastically. This offers many technical advantages: higher profile accuracy, improved fatigue working life and high wear resistance. See **tab. B015** for the calculation of the expected rod fatigue life. **Contact our technical office** in case of heavy duty applications.

Rod corrosion resistance and hardness can be improved selecting the options **K** and **T** (option K affects the strength of standard rod, see **tab. B015** for the calculation of the expected rod fatigue life):

K = Nickel and chrome-plating (for rods from 22 to 110 mm)

Corrosion resistance (rating 10 to ISO 10289):

- 500 h in acetic acid salt spray to ISO 9227 AASS
- 1000 h in neutral spray to ISO 9227 NSS

T = Induction surface hardening and chrome plating

- 56-60 HRC (613-697 HV) hardness

10 CUSHIONING

Cushioning are recommended for applications where: • the piston makes a full stroke with speed over than 0,05 m/s; • it is necessary to reduce undesirable noise and mechanical shocks; • vertical application with heavy loads. The stroke-end cushioning are hydraulic dampers specifically designed to dissipate the energy of the mass connected to the cylinder rod, by progressively increasing the pressure in the cushioning chamber and thus reducing the rod speed before the cylinder's mechanical stroke-end (see the graphics at side). See the **tab. B015** for the max damping energy. When fast adjustable versions are selected, the cylinder is provided with needle valve to optimize cushioning performances in different applications. The regulating screws are supplied fully screwed in (max cushioning effect).

In case of high masses and/or very high operating speeds it is recommended to back them off to optimize the cushioning effect. The adjustment screw has a special design to prevent unlocking and expulsion. The cushioning effect is highly ensured even in case of variation of the fluid viscosity.

Ø Bore	40	50	63	80	100	125	160	200
Ø Rod	22	28	28	36	45	56	70	90
Cushioning length [mm]	Lf front	25	25	29	29	29	27	27
	Lf rear	30	30	32	32	32	41	56

11 POSITION OF THE OIL PORTS AND CUSHIONING ADJUSTMENTS

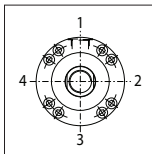

FRONT HEAD: **B1** = oil port position; **E*** = cushioning adjustment position
 REAR HEAD: **X1** = oil port position; **Z*** = cushioning adjustment position.
 The oil ports and cushioning adjustments positions are available, respectively, on sides 1 and 3 for all styles except E (see the figure at side): the style E has the cushioning adjustments on side 2. Cushioning adjustment positions **E***, **Z*** have to be entered only if adjustable cushioning are selected.

Example of model code: CN-50/28 *0500-S308 - A - **B1E3X1Z3**

12 SEALING SYSTEM FEATURES

Sealing system	Material	Features	Max speed [m/s]	Fluid temperature range	Fluids compatibility	ISO Standards for seals	
						Piston	Rod
2	FKM + PTFE	very low friction and high temperatures	4	-20°C to 120°C	Mineral oils HH, HL, HLP, HLP-D, HM, HV, MIL-H-5606 fire resistance fluids HFA, HFB, HFC (water max 45%) HFD-U, HFD-R	ISO 7425/1	ISO 7425/2
4	NBR + PTFE	very low friction and high speeds	4	-20°C to 85°C	Mineral oils HH, HL, HLP, HLP-D, HM, HV, MIL-H-5606 fire resistance fluids HFA, HFC (water max 45%), HFD-U	ISO 7425/1	ISO 7425/2
8	NBR + PTFE + POLYURETHANE	low friction	1	-20°C to 85°C	Mineral oils HH, HL, HLP, HLP-D, HM, HV, MIL-H-5606	ISO 7425/1	ISO 7425/2

The sealing system must be chosen according to the working conditions of the system: speed, operating frequencies, fluid type and temperature. Additional verifications about minimum in/out rod speed is warmly suggested, see **tab. B015**.

Special sealing system for low temperature, high frequencies (up to 20 Hz), long working life and heavy duty are available, see **tab. TB020**. All the seals, static and dynamic, must be periodically replaced: proper spare kits are available, see section [7]. Contact our technical office for the compatibility with other fluids not mentioned below and specify type and composition. See section [4] for fluid requirements.

13 AIR BLEEDS

CODES: **A** = front air bleed; **W** = rear air bleed

The air in the hydraulic circuit must be removed to avoid noise, vibrations and irregular cylinder's motion: air bleed valves are recommended to realize this operation easily and safely.

Air bleeds are positioned on side 3 for all styles except E: the style E has the air bleeds on side 2, see section [1].

For a proper use of the air-bleed (see figure on side) unlock the grub screw ① with a wrench for hexagonal head screws, bleed-off the air and retighten as indicated in table at side.

14 FLUID REQUIREMENTS

Cylinders and servocylinders are suitable for operation with mineral oils with or without additives (**HH, HL, HLP, HLP-D, HM, HV**), fire resistant fluids (**HFA** oil in water emulsion, 90-95% water and 5-10% oil; **HFB** water in oil emulsion, 40% water; **HFC** water glycol, max 45% water) and synthetic fluids (**HFD-U** organic esters, **HFD-R** phosphate esters). The fluid must have a viscosity within 15 and 100 mm²/s, a temperature within 0 and 70°C and fluid contamination class ISO 20/18/15 according to ISO 4406 NAS1638 class 9, see also filter section at www.atos.com or KTF catalog.

ROD-PISTON COUPLING

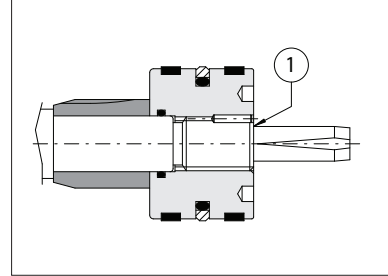

The rod and piston are mechanically coupled by a threaded connection in which the thread on the rod is at least equal to the external thread KK, indicated in the table [7]. The piston is screwed to the rod by a prefixed tightening torque in order to improve the fatigue resistance. The stop pin ① avoids the piston unscrewing.

Lf is the total cushioning length. When the stroke-end cushioning are used as safety devices, to mechanically preserve the cylinder and the system, it is advisable to select the cylinder's stroke longer than the operating one by an amount equal to the cushioning length Lf; in this way the cushioning effect does not influence the movement during the operating stroke.

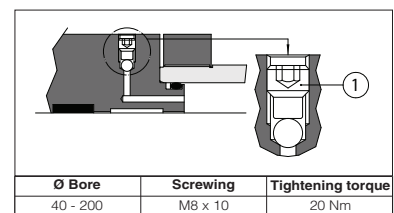
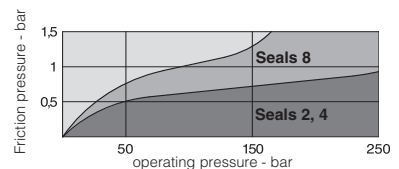
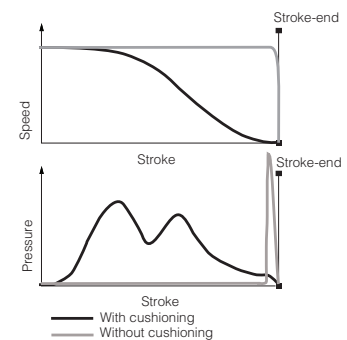
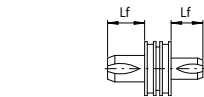

Ø Bore	Screwing	Tightening torque
40 - 200	M8 x 10	20 Nm

15 CYLINDERS MASSES [kg] (tolerance ± 5%)

Ø Bore [mm]	Ø Rod [mm]	MASS FOR STYLE X		ADDITIONAL MASSES according to mounting styles and options								
		Stroke 100 mm	Each 100 mm more	Styles A, B	Style E	Style L	Styles N, P	Styles D, S	Front cushioning	Rear cushioning	Each 50 mm spacer	
40	22	7,36	1,18	1,16	1,16	1,58	0,82	0,29	0,09	0,50	0,93	
	28	7,60	1,36									
50	28	12	1,55	2	3,80	2,87	1,54	0,64	0,20	0,80	1,30	
	36	12,50	1,86									
63	36	19,50	2,30	3,28	5,80	4,54	2,70	1,32	0,30	1	1,97	
	45	20	2,75									
80	45	28	2,87	5,26	9,04	6,79	4,30	2,36	0,50	1	2,78	
	56	28,50	3,55									
100	56	48,50	4,65	7,76	15,72	10,36	5,96	4,76	0,80	1,50	4,43	
	70	49,50	5,73									
125	70	76,50	7,26	9,76	24,68	18,14	8,08	7,28	1,20	2	6,93	
	90	78,50	9,23									
160	90	126	11,47	14,54	38,16	35	NA	15,64	1,70	3	11,13	
	110	128,50	13,93									
200	110	233,50	18,31	22,66	63,36	58,88	NA	32,20	2,50	5	17,75	
	140	238	22,94									

Note: the masses related to the other options, not indicated in the table, don't have a relevant influence on the cylinder's mass

16 CYLINDER SECTION

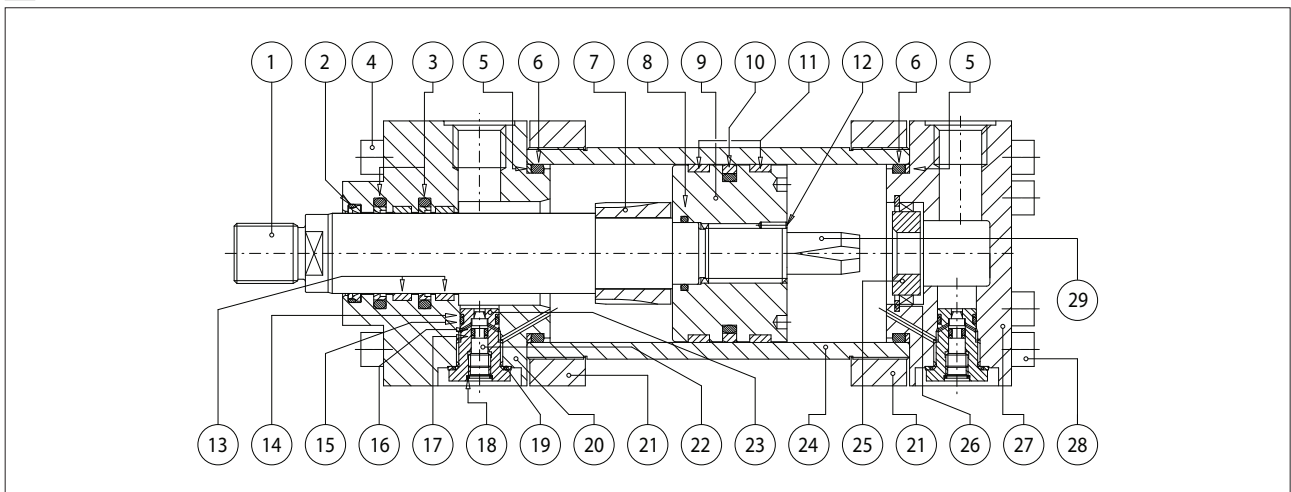

POS.	DESCRIPTION	MATERIAL	POS.	DESCRIPTION	MATERIAL	POS.	DESCRIPTION	MATERIAL
1	Rod	Chrome plated steel	11	Piston guide rings	PTFE	21	Counterflange	Steel
2	Wiper	NBR / FKM and PTFE	12	Screw stop pin	Steel	22	Cushioning adjustment screw	Steel
3	Rod seal	NBR / FKM and PTFE	13	Rod guide rings	Phenolic resin	23	Cushioning adjustment plug	Steel
4	Screw	Steel class 12.9	14	Anti-extrusion ring	PTFE	24	Cylinder housing	Steel
5	Anti-extrusion ring	PTFE	15	O-ring	FKM	25	Rear cushioning sleeve	Bronze
6	O-ring	NBR / FKM	16	O-ring	FKM	26	Toroidal ring	Steel
7	Front cushioning piston	Steel	17	Anti-extrusion ring	PTFE	27	Rear head	Steel / Cast iron
8	O-ring	NBR / FKM	18	Seeger	Steel	28	Screw	Steel class 12.9
9	Piston	Steel	19	Seal	FKM	29	Rear cushioning piston	Steel
10	Piston seal	NBR / FKM and PTFE	20	Front head	Steel / Cast iron			

17 SPARE PARTS - SEE TABLE SP-B180

Example for seals spare parts code

G 8 - C N - 50 / 28

Sealing system

Cylinder series

Bore size [mm]

Rod diameter [mm]